

ACCUHALER

How to use the Accuhaler

1. Open the Accuhaler by holding outer casing of the Accuhaler upright in one hand whilst pushing the thumb and grip away until a click is heard.
2. Hold the Accuhaler with the mouth-piece towards you slide the lever away until it clicks. This makes the dose available for inhalation and moves the dose counter on.
3. **Holding the Accuhaler level, breathe out fully, away from the device, put mouthpiece in mouth and seal lips around it. Inhale/suck in quickly and deeply.**
4. Remove the Accuhaler from mouth and hold breath for about 10 seconds.
5. Contains a lactose carrier, therefore will have a sweet taste.
6. To close the device, slide the outer casing back towards you as far as it will go until it clicks.
7. For the next dose repeat steps 1-5. Only one dose of medication is available at a time.



BREEZHALER

How to use the Breezhaler

1. Hold the device upright and lift off the cover
2. Hold the base of the device and push back on the mouthpiece until the lid opens completely
3. Peel back the foil (immediately before use) using the foil tab until one capsule is fully visible. Discard any capsules that have been inadvertently exposed to the air
4. Remove capsule and place it in the chamber in the middle of the Breezhaler
5. Close the mouthpiece and press down until you hear a click
6. **Press the blue button on the sides of the device as far as it will go (just once) and then release (this will pierce the capsule).** You will hear a click
7. Hold the inhaler upright with the mouthpiece pointing upwards. Breathe out completely. Be careful not to breathe out into the inhaler
8. Seal your lips tightly around the mouthpiece
9. Sitting upright and keeping your head upright **breathe in quickly and deeply.** You will hear the capsule vibrate when you breathe in correctly
10. Remove the inhaler from your mouth and breathe out normally
11. Hold for your breath for as long as is comfortable
12. Open the lid and check the capsule is empty
13. Tip out the capsule and throw it away



EASI-BREATHE

How to use the Easi-Breathe

1. Shake the inhaler
2. Hold the device upright
3. Open the cap
4. Breathe out fully
5. Keep the inhaler upright and place the mouthpiece in the mouth and close teeth and lips around it
6. Do not cover the air holes on the top of the device
7. Breathe in steadily through the mouthpiece. **Continue to breath in steadily when the inhaler 'puffs'**
8. Hold your breath for about 10 seconds
9. Continue to hold the inhaler upright and close the cap immediately
10. For a second dose wait for a few seconds before repeating steps 1-8

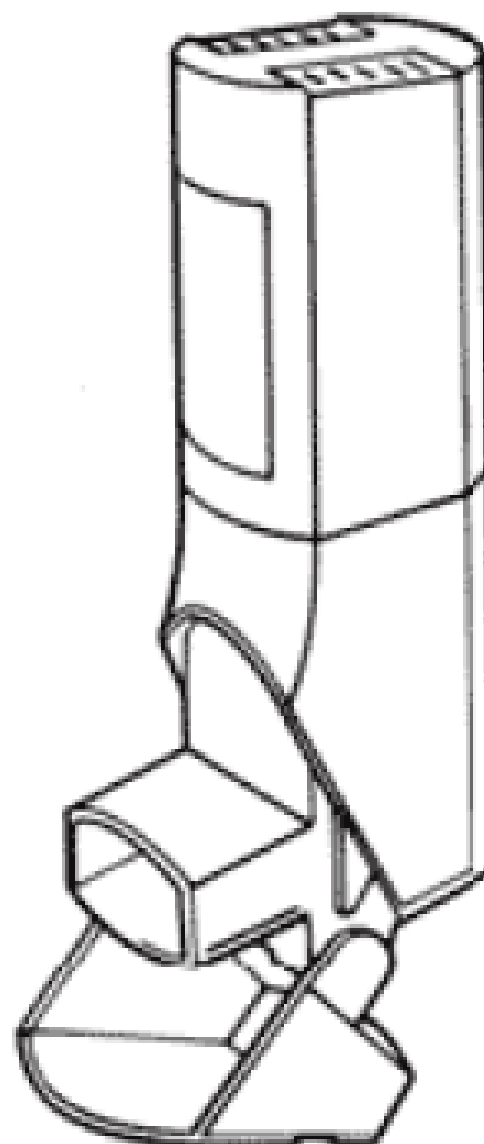

EASYHALER

How to Use an Easyhaler

1. Shake the device, and then hold the device in an upright position
2. Remove the mouthpiece and cap
3. Press the top of the device once. You will hear a click
4. **Breathe out fully** and then place the mouthpiece of the Easyhaler between your teeth. Close and seal your lips around the mouthpiece
5. **Take a strong and deep breath through the device.** Hold your breath for 10 seconds then breathe out, away from the device. Contains a lactose carrier and will taste sweet
6. Repeat steps 3 to 5 if you need to take another dose of inhaler medicine
7. Replace the mouthpiece cap

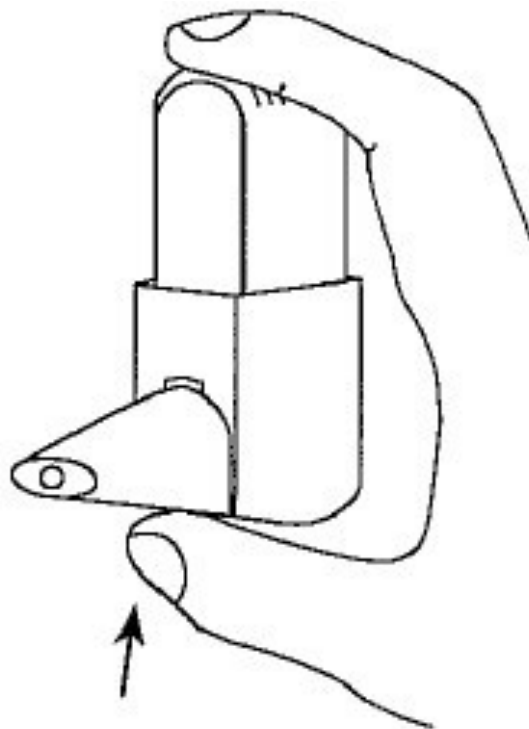

ELLIPTA

How to use the Ellipta

1. Hold the device upright and open the cover once you are ready to take a dose
2. Slide the cover down until you hear a 'click'
3. While holding the inhaler away from your mouth, **breathe out as far as is comfortable**
4. Place the mouthpiece between your lips and close your lips firmly around it
5. **Take one long, steady deep breath in**
6. Hold your breath for at least 3-4 seconds
7. Remove the inhaler from your mouth and breathe out slowly
8. Slide the cover upwards as far as it will go to cover the mouthpiece



Flo-Tone Device and Pressurised Metered Dose Inhaler (pMDI)

How to use the Flo-tone device with pMDI

1. Secure cap to Flo-Tone CR (first use)
2. Remove the cap from your pMDI and check for debris
3. If you have not used the device for over a week let off one dose by holding the device upright and pressing down on the canister
4. Insert Flo-Tone CR into pMDI mouth-piece
5. Shake the inhaler
6. **Breathe out fully**
7. Hold the device upright
8. Place the Flo-Tone CR mouthpiece in the mouth between the teeth and **seal lips** around it
9. Inhale gently to activate the Flo-Tone CR whistle and press the canister down
10. **Breathe in steadily and deeply and keep the Flo-Tone whistling**
11. Hold the breath for 10 seconds, or as long as is possible and then breath out gently
12. Wait for 30 seconds before repeating steps 2-8
13. Replace the Flo-Tone cap and leave inserted within the pMDI device

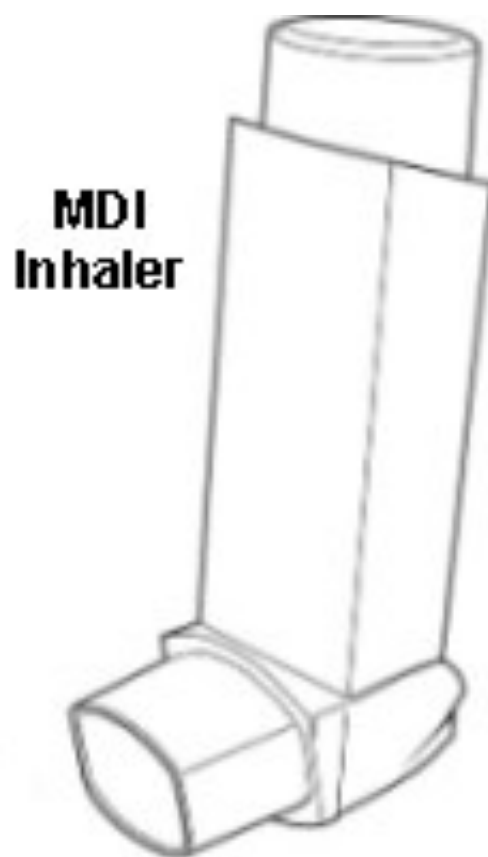

GENUAIR

How to Use a Genuair

1. Keep the device level, remove the mouthpiece cap by squeezing the arrows at the sides gently and sliding forwards
2. Hold the device horizontally with the mouthpiece towards you
3. Press down the button at the back of the inhaler (at the opposite end to the mouthpiece) all the way down and release, until you hear a click.
4. The control window at the mouthpiece end of the device will change from red to green
5. Do not hold the button down while inhaling.
6. **Breathe out fully** away from the inhaler. Do not breathe out into the device
7. Place the mouthpiece in your mouth and seal your lips around the mouthpiece.
8. **Breathe in fully and deeply through the device even after you hear the click to ensure the full dose is inhaled.**
9. You will hear a click if you breathe through the device correctly and the control window will change from green to red. If the control window has changed to red the dose has been inhaled correctly
10. Hold your breath for a few seconds before taking the device out of your mouth and breathing out slowly through the nose
11. Repeat steps 2 to 10 if a further dose of inhaler medicine is needed
12. Replace the mouthpiece cap
13. The last dose the inhaler will lock to show that there is only one dose left



HANDIHALER

How to use:

1. Hold the device upright and open the lid, press the green piercing button completely in and let go
2. Open the lid completely by pulling it upwards.
3. Then open the mouthpiece by pulling it upwards
4. Separate the blister strips by tearing along the perforations
5. Peel back the foil (immediately before use) using the foil tab until one capsule is fully visible. Discard any capsules that have been inadvertently exposed to the air
6. Remove capsule and place it in the chamber in the middle of the Handihaler
7. Close the mouthpiece and press down until you hear a click
8. Press the green button on the side as far as it will go and then release (this will pierce the capsule, once only)
9. To inhale the medicine. **Breathe out completely.** Be careful not to breathe out into the inhaler
10. Seal your lips tightly around the mouthpiece
11. Sitting upright and keeping your head upright **breathe in slowly and deeply.** You will hear the capsule vibrate when you breathe in correctly
12. Hold for your breath for as long as is comfortable
13. Remove the inhaler from your mouth and breathe out normally
14. To empty the capsule open the lid and mouthpiece
15. Tip out the capsule and throw it away
16. Close the mouthpiece and lid

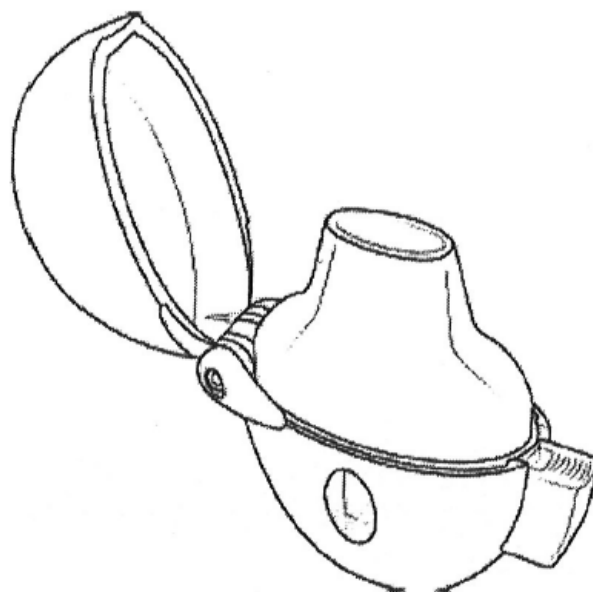

NEXTHALER

How to use the Nexthaler

1. Open the cover fully with your inhaler in the upright position
2. Note the number of doses left on the dose counter
3. Sit or stand upright
4. **Breathe out as far as is comfortable**
5. Do not breathe out through your inhaler
6. Seal your lips around the mouthpiece
7. Do not cover the air vent when holding the device
8. Do not inhale through the air vent
9. **Take a quick deep breath through your mouth**
10. You will hear or feel a click when the dose has been released from the device
11. After the click, continue to inhale deeply to ensure the dose reaches the lungs (5 seconds)
12. Remove the inhaler from your mouth
13. Hold your breath for 10 seconds
14. Breathe out slowly
15. Close the cover fully with the inhaler in the upright position
16. Check that the dose counter has gone down by one. This will indicate that you have successfully inhaled a dose
17. If you need to take another dose, repeat steps 1-16

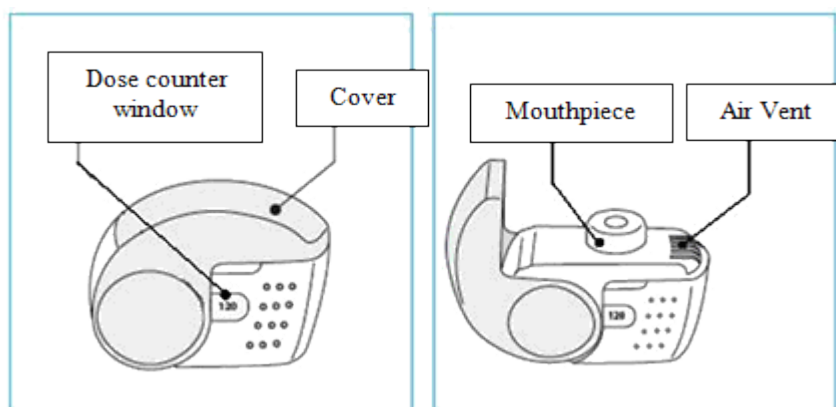

Pressurised Metered Dose Inhaler (pMDI)

How to use the pMDI

1. Remove the cap and check pMDI for debris
2. If you have not used the device for over a week let off one dose by holding the device upright and pressing down on the canister
3. Shake the inhaler
4. **Breathe out fully**
5. Hold the device upright
6. Place the mouthpiece in the mouth between the teeth and seal lips around it
7. Inhale gently
8. Press the canister down
9. **Breathe in steadily and deeply**
10. Hold the breath for 10 seconds, or as long as is possible and then breath out gently
11. Wait for 30 seconds before repeating steps 2-8
12. Replace the cap

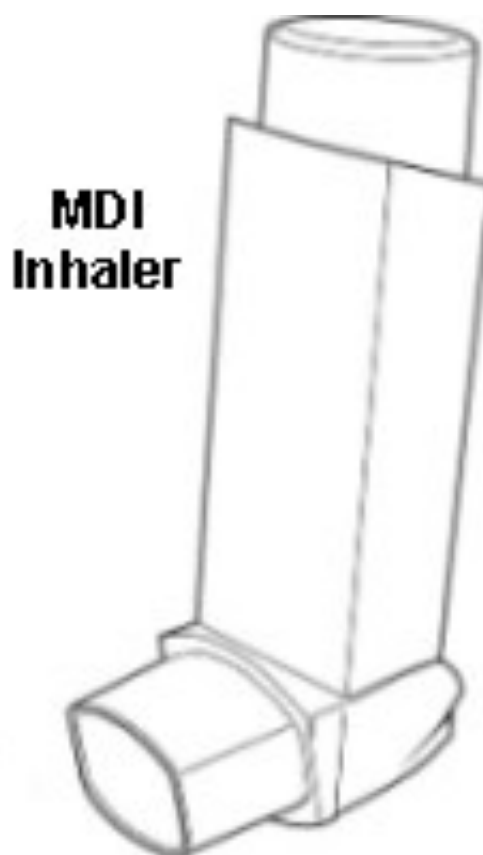

AUTOHALER

How to use the Autohaler

1. Remove protective mouthpiece cap
2. Shake the inhaler
3. Hold the inhaler upright and push the lever right up
4. Breathe out gently
5. Keep the inhaler upright
6. Place the mouthpiece in the mouth and seal lips round it
7. The air holes must not be blocked at the base of the device
8. Breathe in steadily through mouth
9. **Do not stop breathing when the inhaler 'clicks' and continue taking a really deep breath**
10. Hold the breath for 10 seconds
11. Breathe out gently
12. Wait several seconds before repeating steps 2-11 for a second dose
13. The level must be pushed up ('on') before each dose, and pushed down again ('off') afterwards, otherwise it will not operate
14. Replace cap
15. If using the device for the first time, it should be primed by lifting the lever on the top, and then pushing the white slide on the bottom of the device to release the medication. Repeat this action one more time



Autohaler

Pressurised Metered Dose Inhaler (pMDI) and Spacer

How to use the pMDI and spacer (tidal breathing technique)

1. Remove the cap and check pMDI for debris
2. If you have not used the device for over a week let off one dose by holding the device upright and pressing down on the canister
3. Shake the inhaler
4. Hold the device upright and place the pMDI mouthpiece into the back of the spacer
5. Remove the cap from the mouthpiece of the spacer, if applicable
6. Place the mouthpiece between the teeth and **seal lips** around it
7. Press the canister down once to release a dose
8. Breathe in and out slowly and gently 5 times. You should hear a clicking noise with Volumatic spacers
9. Wait for a 30 seconds before repeating steps 2-8
10. Replace the cap
11. If you hear a whistling sound you have breathed in too quickly

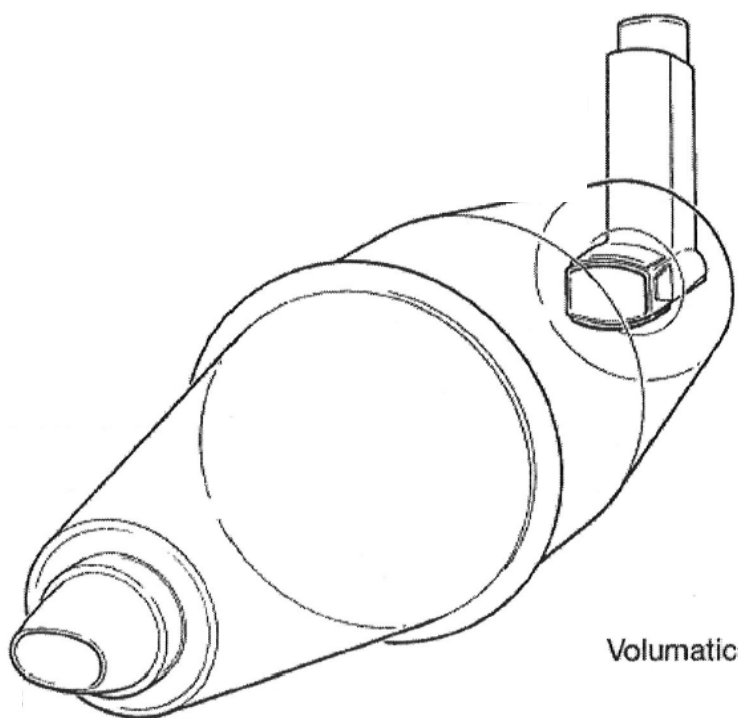

RESPIMAT

Preparing the Respimat inhaler for the first time

1. With the plastic cap closed, press the aqua safety catch and pull off the clear base from the inhaler
2. Take the cartridge out of the box. Push the narrow end of the cartridge into the inhaler. The base cartridge will not sit flush with the inhaler
3. Push the cartridge gently against a firm surface to ensure that it has gone all the way into the inhaler
4. Do not remove the cartridge once it has been inserted into the inhaler
5. Put the clear base back in place. Do not remove the clear base again

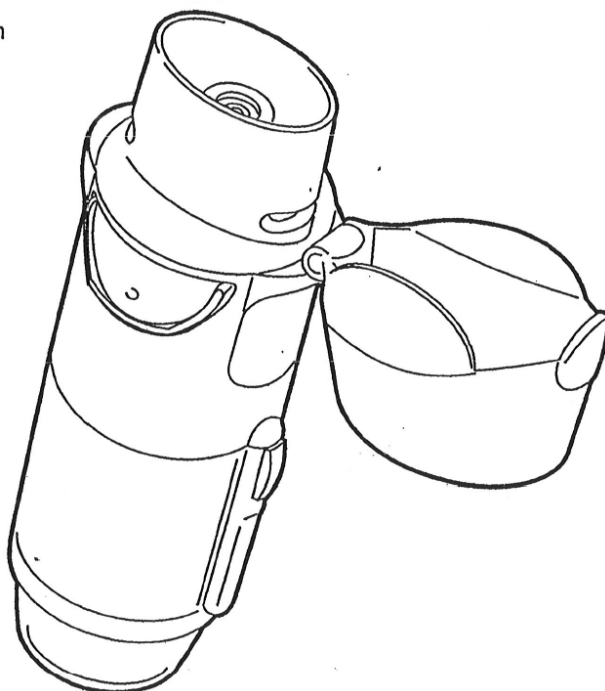

Preparing the Respimat inhaler for first time use

- 1.
2. Hold the Respimat inhaler upright, with the plastic cap closed. Turn the base firmly until it clicks (half a turn)
3. Open the aqua plastic cap until it is fully open
4. Point the Respimat inhaler towards the ground. Press the dose release button. Close the plastic cap
5. Repeat the steps 1-3 until a spray is visible. Once the spray is visible, you must repeat steps 1-3 three more times to make sure the inhaler is prepared for use

How to use the Respimat inhaler

1. Hold the Respimat inhaler upright, with the lid closed
2. Turn the clear base firmly until it clicks (half a turn)
3. Open the plastic cap until it is fully open
4. **Breathe out slowly and fully** and then place the mouthpiece in the mouth and seal your lips around it without covering the air vents
5. **While taking in a slow, deep breath through your mouth press the dose release button and continue to breathe in slowly for as long as you can**
6. Remove the Respimat from your mouth and hold your breath for about 10 seconds
7. Replace the cap after use
8. If Respimat inhaler has not been used for more than 7 days release one puff towards the ground

Turbohaler

How to use the Turbohaler

1. Unscrew and lift off the white cover
2. Hold the inhaler upright and twist the grip base as far as it will go in both directions. You will hear a clicking sound
3. **Breathe out fully** away from the Turbohaler mouthpiece
4. Place the mouthpiece between the teeth and seal lips.
5. **Breathe in as deeply as possible.**
6. Remove the inhaler from the mouth and breath out
7. For a further dose repeat steps 2-7
8. Replace the white cover

